

### **Domiled™**

Synonymous with function and performance, the Domiled™ series is perfectly suited for a variety of cross-industrial applications due to its small package outline, durability and superior brightness.



### **Features:**

- > High brightness surface mount LED.
- > Based on InGaN technology.
- > 120° viewing angle.
- > Small package outline (LxWxH) of 3.2 x 2.8 x 1.8mm.
- > Qualified according to JEDEC moisture sensitivity Level 2.
- > Compatible to both IR reflow soldering and TTW soldering.
- > Environmental friendly; RoHS compliance.



### **Applications:**

- > Automotive: interior applications, eg: switches, telematics, climate control system, dashboard, etc.
- > Consumer Appliances: LCD illumination as in PDAs, LCD TV.
- > Communication: indicator and backlight in mobilephone.
- > Display: full color display video notice board.
- > Industry: white goods (eg: Oven, microwave, etc.).



Part Ordering Number	Chip Technology / Color	Viewing Angle°	Luminous Intensity @ IF = 20mA IV (mcd)
<b>DDW-URD-UV1-1</b>	<b>InGaN</b>	<b>120</b>	<b>450.0 - 900.0</b>
• DDW-URD-U1	White		450.0 - 560.0
• DDW-URD-U2			560.0 - 715.0
• DDW-URD-V1			715.0 - 900.0

NOTE

1. All part number above comes in a quantity of 2000 units per reel.
2. Other luminous intensity groups are also available upon request.
3. Luminous intensity is measured with an accuracy of  $\pm 11\%$ .
4. Wavelength binning is carried for all units as per the wavelength-binning table. Only one wavelength group is allowed for each reel.
5. An optional Vf binning is also available upon request. Binning scheme is as per following table.

**Vf Bining (Optional)**

Vf Bin @ 20 mA	Forward Voltage (V)
Standard	3.35 ... 4.25
01	3.35 ... 3.65
02	3.65 ...3.95
03	3.95 ...4.25

Forward Voltage, Vf is measured with an accuracy of  $\pm 0.1$  V.

**Absolute Maximum Ratings**

	Maximum Value	Unit
DC forward current	20	mA
Peak pulse current; (tp $\leq$ 10 $\mu$ s, Duty cycle = 0.005)	200	mA
Reverse Voltage	5	V
ESD Thershold (HBM)	2	kV
LED junction temperature	125	°C
Operating temperature	-40 ... +100	°C
Storage temperature	-40 ... +100	°C
Power dissipation (at room temperature)	85	mW

**DDW, White Color Grouping**

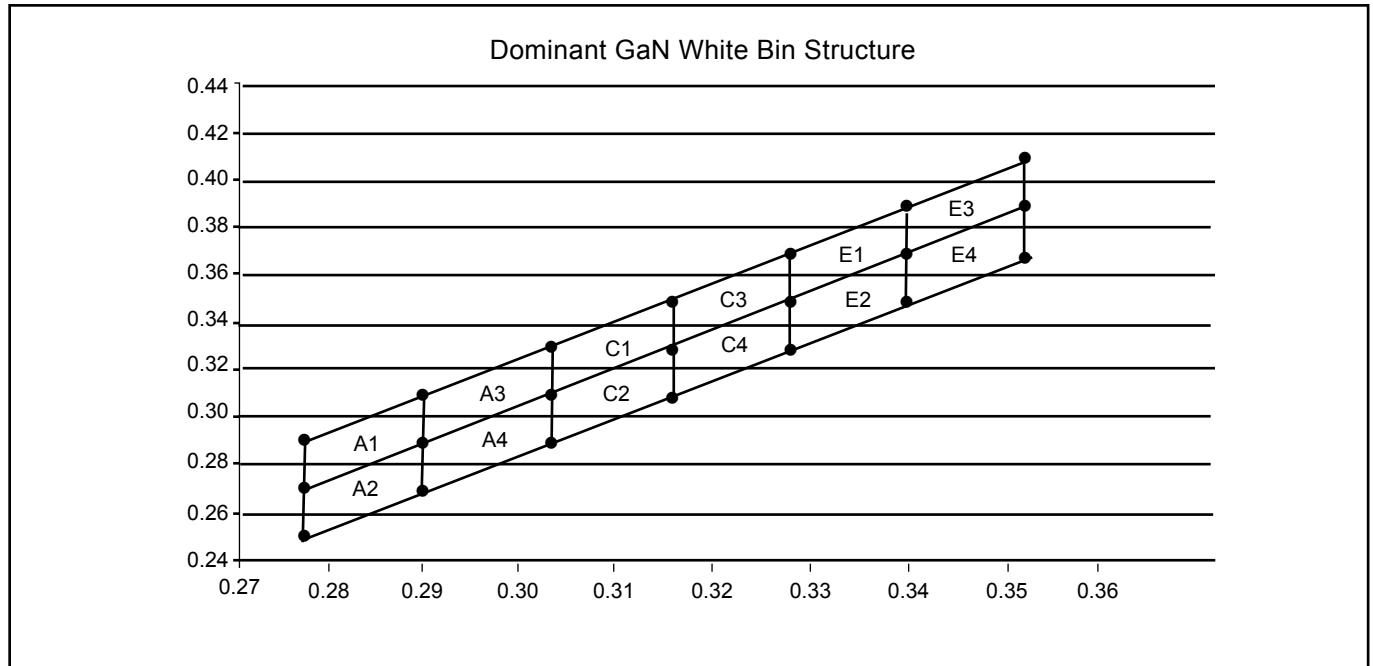

Chromaticity coordinate groups are measured with an accuracy of  $\pm 0.01$ .

Bin		W			
A1	Cx	0.2775	0.2900	0.2900	0.2775
	Cy	0.2732	0.2939	0.3114	0.2907
A2	Cx	0.2775	0.2900	0.2900	0.2775
	Cy	0.2557	0.2764	0.2939	0.2732
A3	Cx	0.2900	0.3025	0.3025	0.2900
	Cy	0.2939	0.3146	0.3321	0.3114
A4	Cx	0.2900	0.3025	0.3025	0.2900
	Cy	0.2764	0.2971	0.3146	0.2939
C1	Cx	0.3025	0.3150	0.3150	0.3025
	Cy	0.3146	0.3354	0.3529	0.3321
C2	Cx	0.3025	0.3150	0.3150	0.3025
	Cy	0.2971	0.3179	0.3354	0.3146
C3	Cx	0.3150	0.3275	0.3275	0.3150
	Cy	0.3354	0.3561	0.3736	0.3529
C4	Cx	0.3150	0.3275	0.3275	0.3150
	Cy	0.3179	0.3386	0.3561	0.3354

Bin		X			
E1	Cx	0.3275	0.3400	0.3400	0.3275
	Cy	0.3561	0.3768	0.3943	0.3736
E2	Cx	0.3275	0.3400	0.3400	0.3275
	Cy	0.3386	0.3593	0.3768	0.3561
E3	Cx	0.3400	0.3525	0.3525	0.3400
	Cy	0.3768	0.3975	0.4150	0.3943
E4	Cx	0.3400	0.3525	0.3525	0.3400
	Cy	0.3593	0.3800	0.3975	0.3768

Dominant color coordinate is measured with an accuracy of  $\pm 0.01$ .

**Relative Luminous Intensity Vs Forward Current**

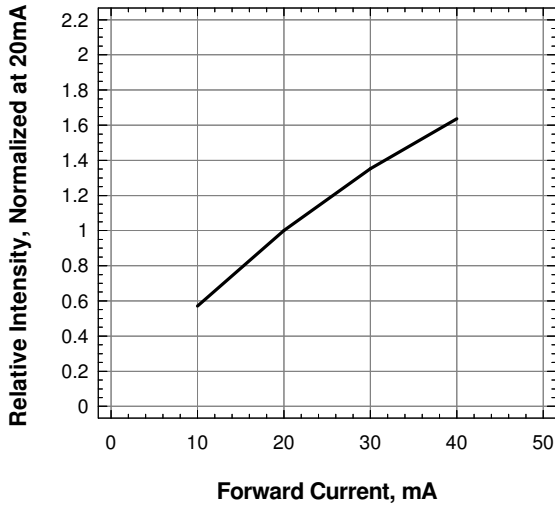

**Forward Current Vs Forward Voltage**

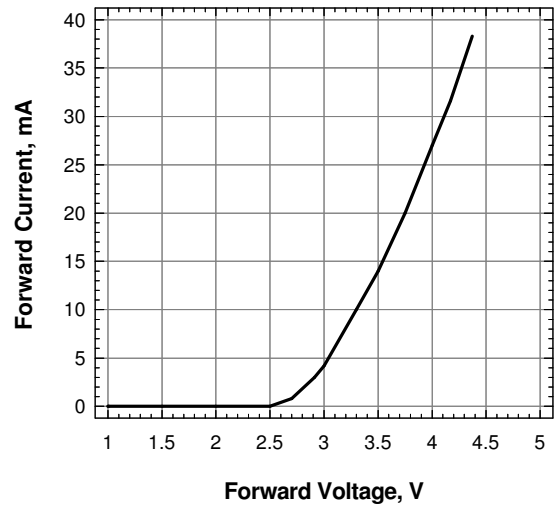

**Maximum Forward Current Vs Temperature**

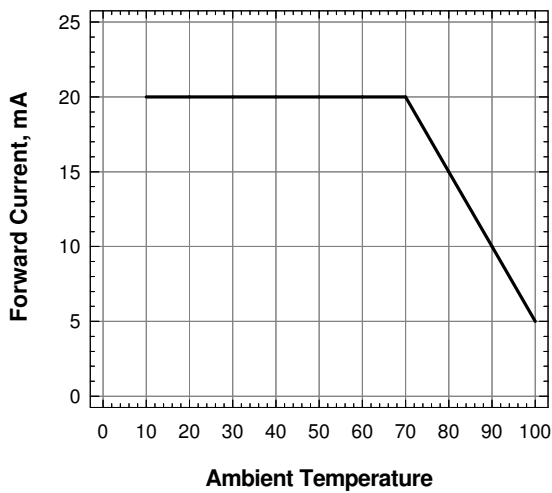

**Relative Intensity Vs Wavelength**

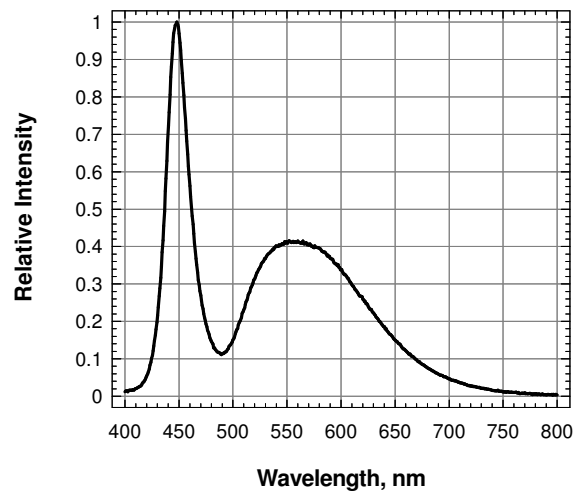

**Radiation Pattern**

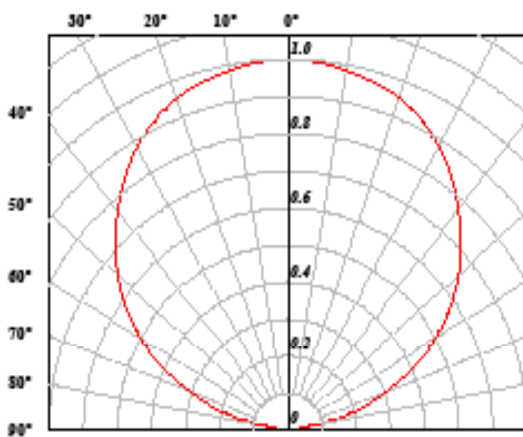

**DomiLED™ • InGaN White : DDx-xRx Package Outlines**

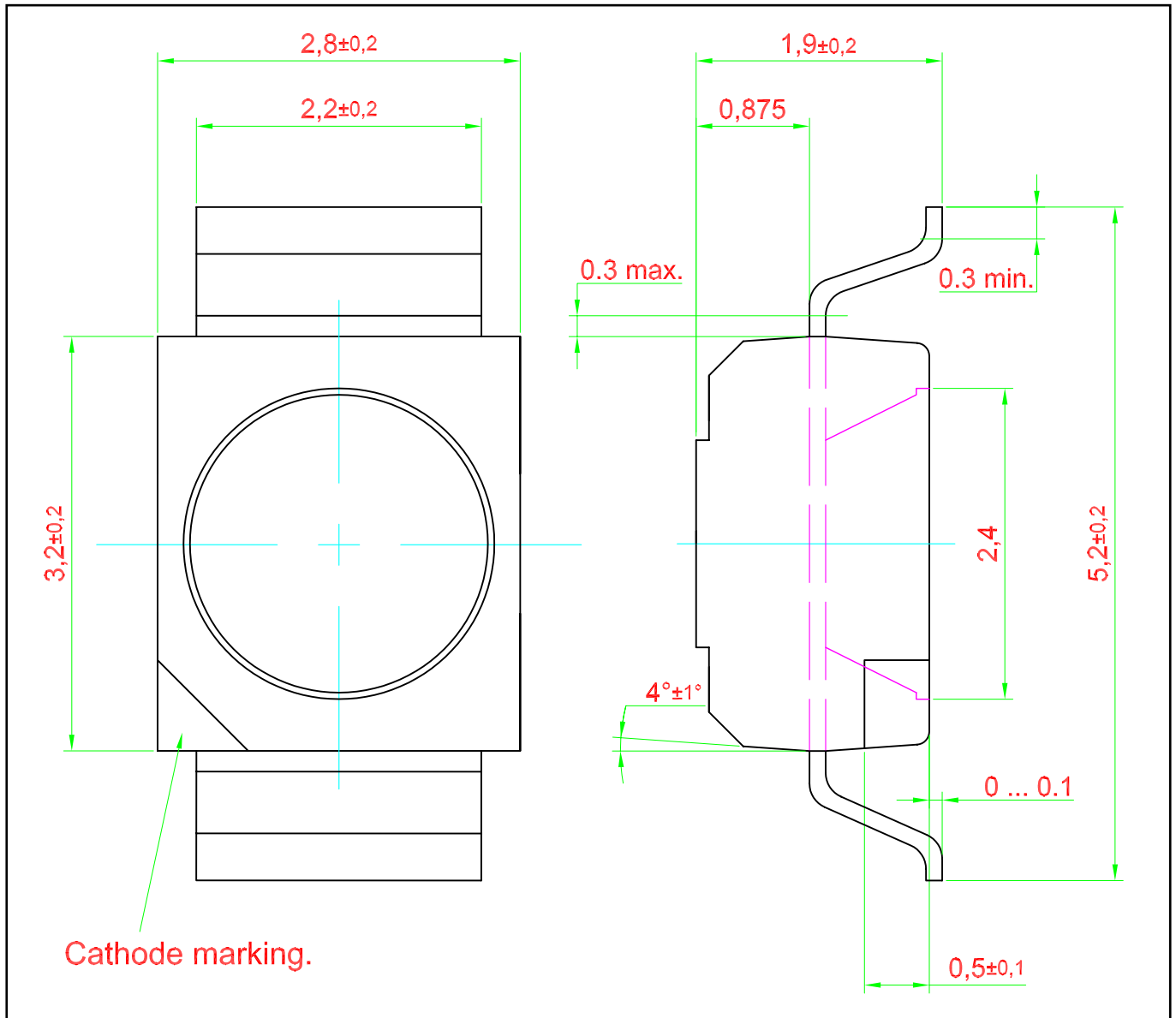

**Recommended Solder Pad**

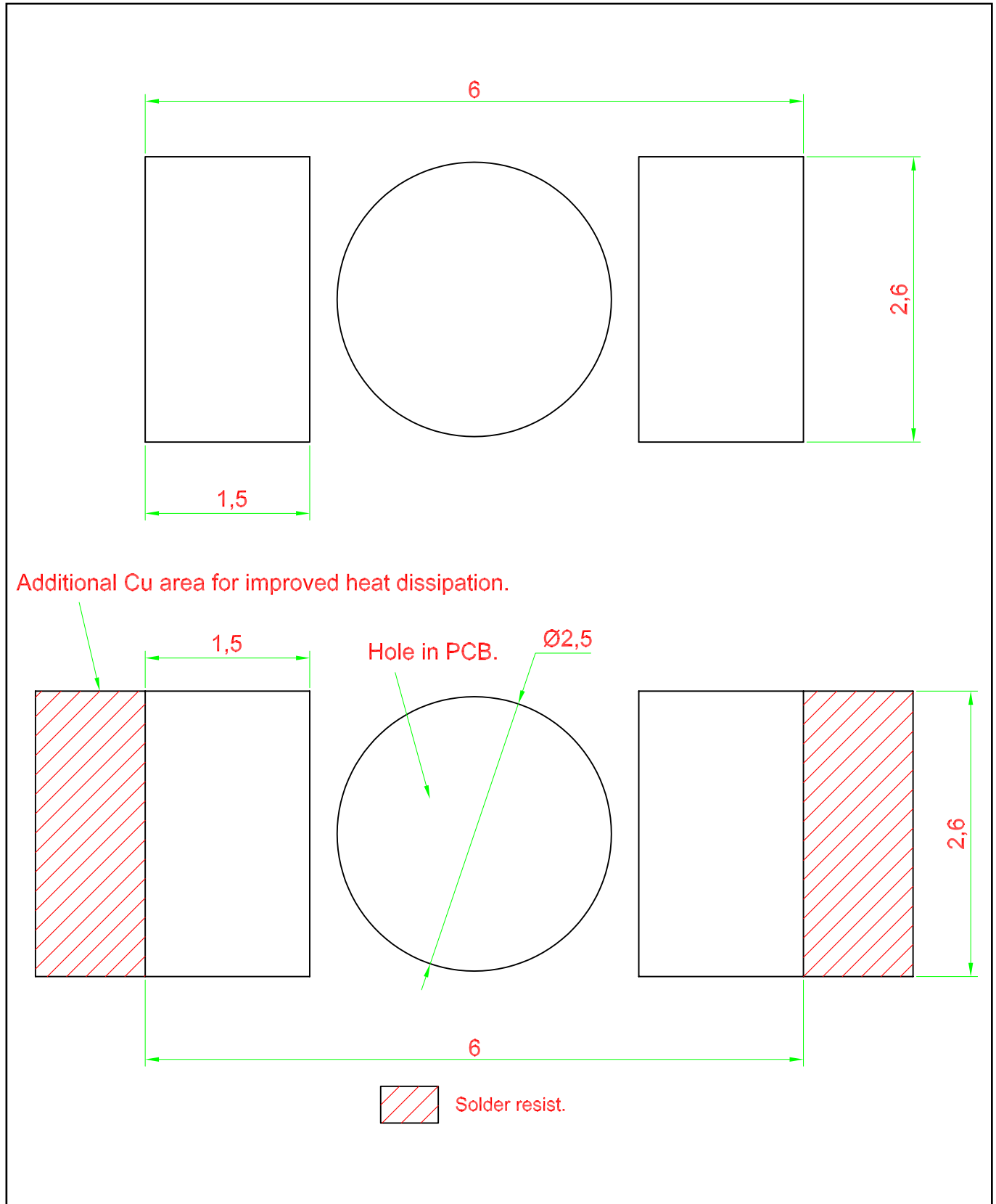

### Taping and orientation

- Reels come in quantity of 2000 units.
- Reel diameter is 180 mm.

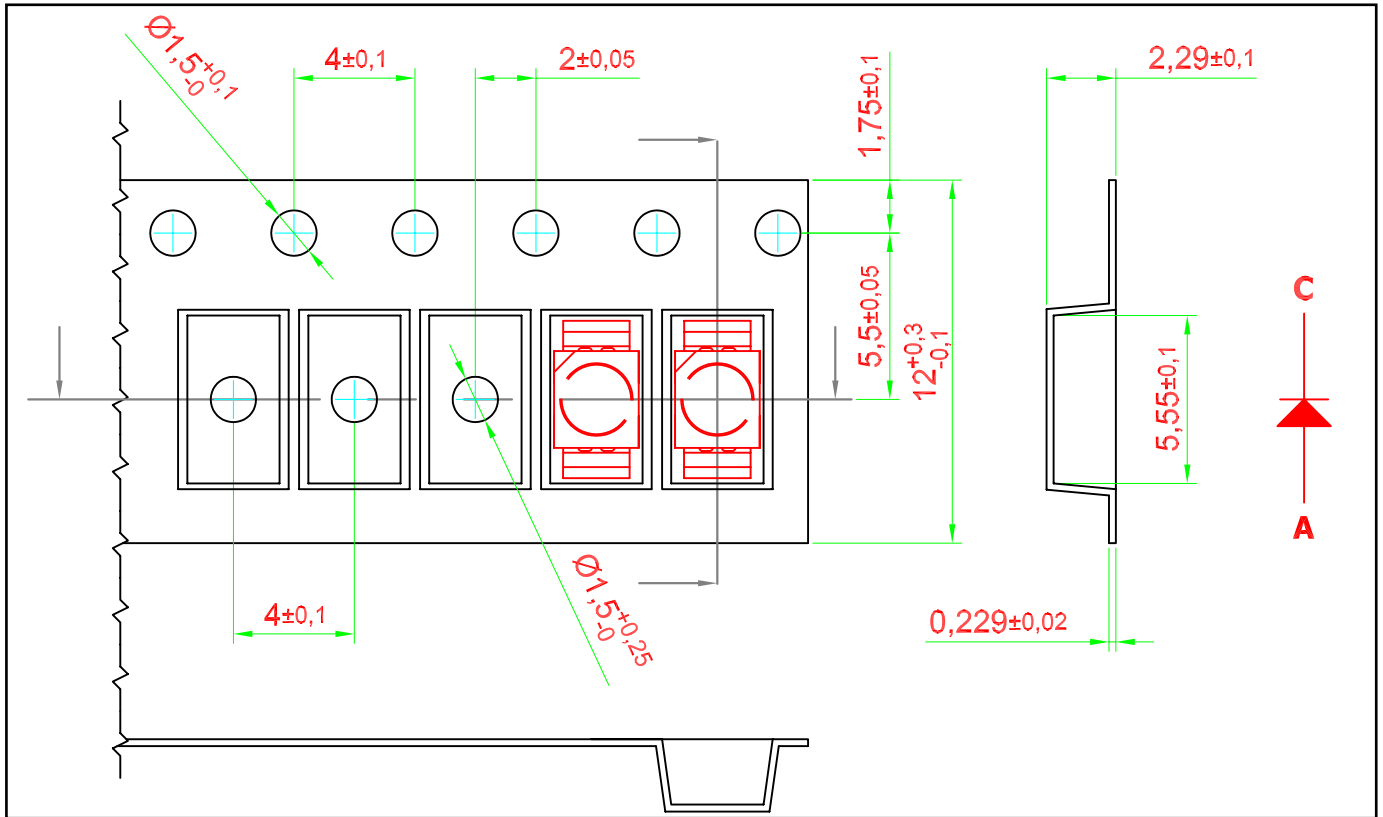

200 mm min. for  $\varnothing 180$  reel.

480 mm min. for  $\varnothing 180$  reel.

200 mm min. for  $\varnothing 330$  reel.

960 mm min. for  $\varnothing 330$  reel.

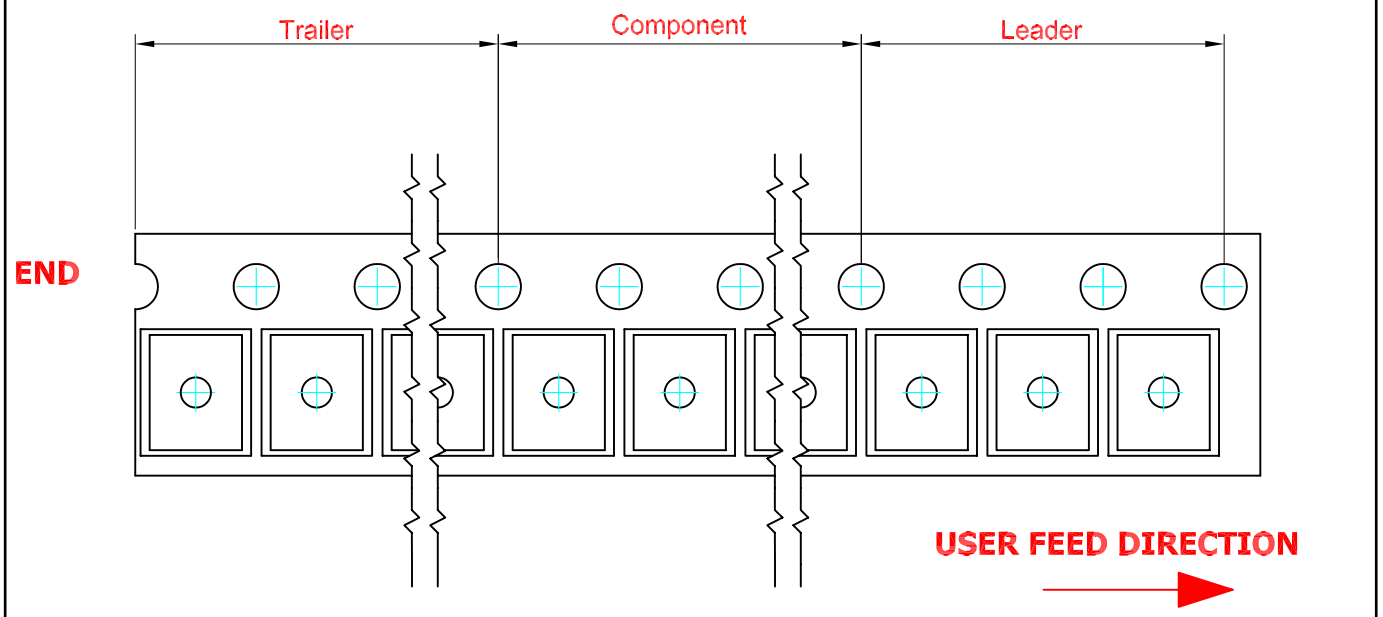

**Packaging Specification**

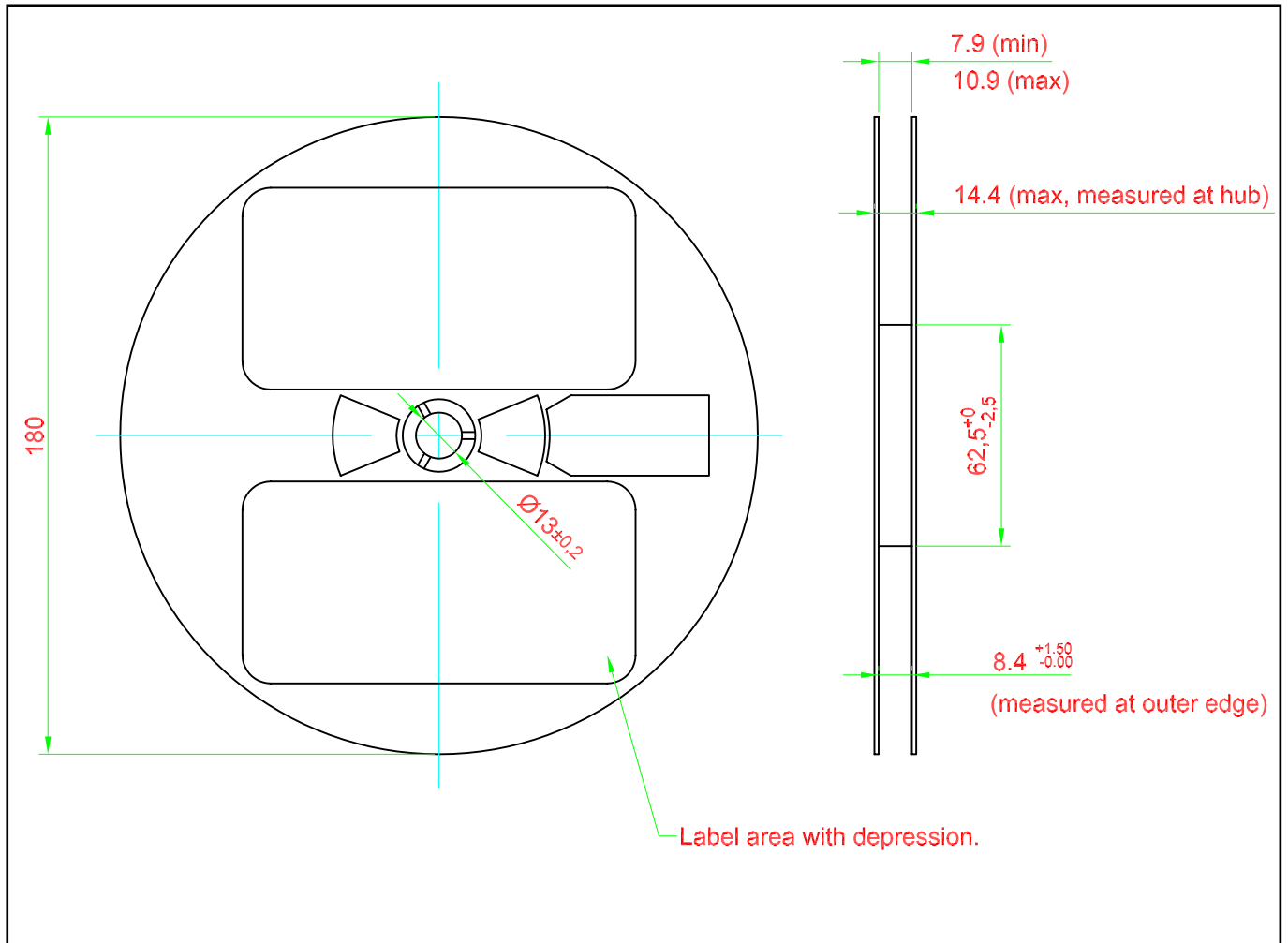



**Packaging Specification**

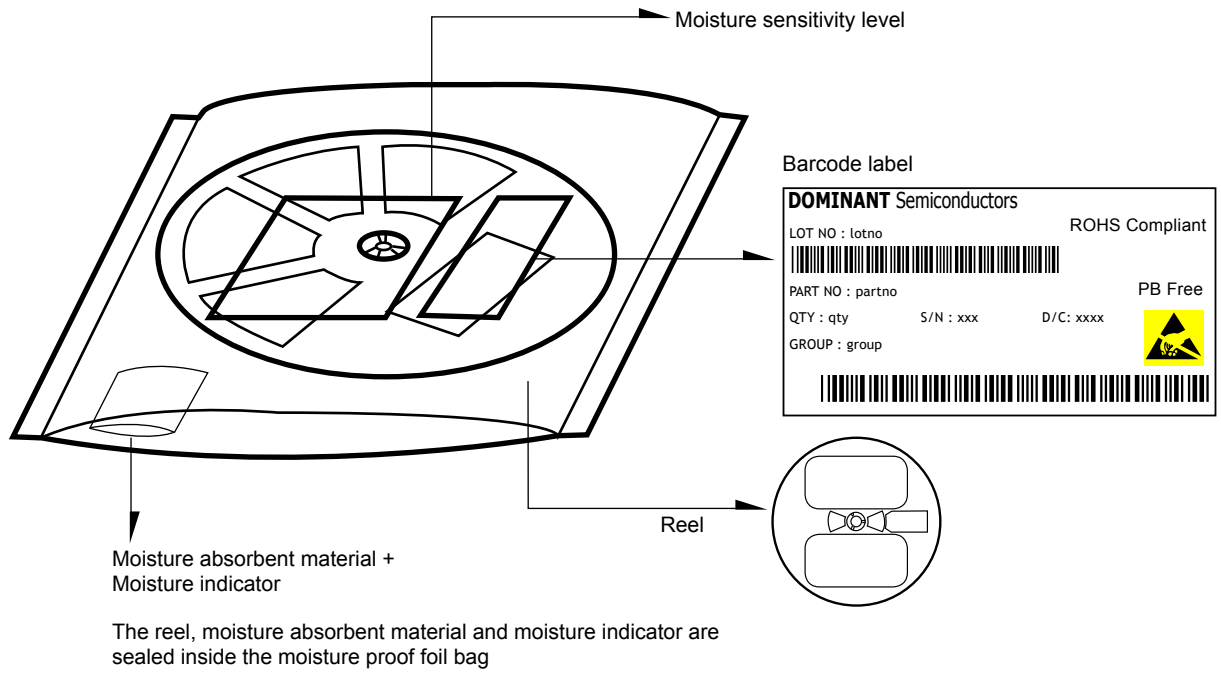

	Average 1pc DomiLED/Multi DomiLED	1 completed bag (2000pcs)
Weight (gram)	0.034	190 ± 10

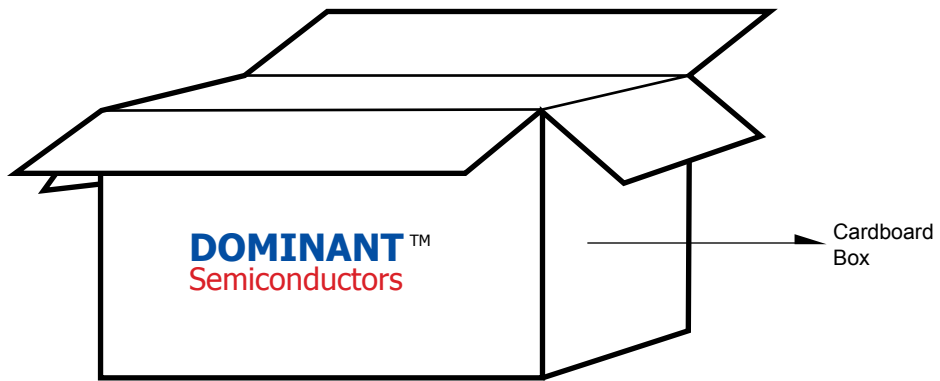

**For DomiLED™**

Cardboard Box Size	Dimensions (mm)	Empty Box Weight (kg)	Reel / Box	Quantity / Box (pcs)
Small	300 x 250 x 250	0.58	15 reels MAX	30,000 MAX
Large	416 x 516 x 476	1.74	55 reels MAX	110,000 MAX

**Recommended Sn-Pb IR-Reflow Soldering Profile**

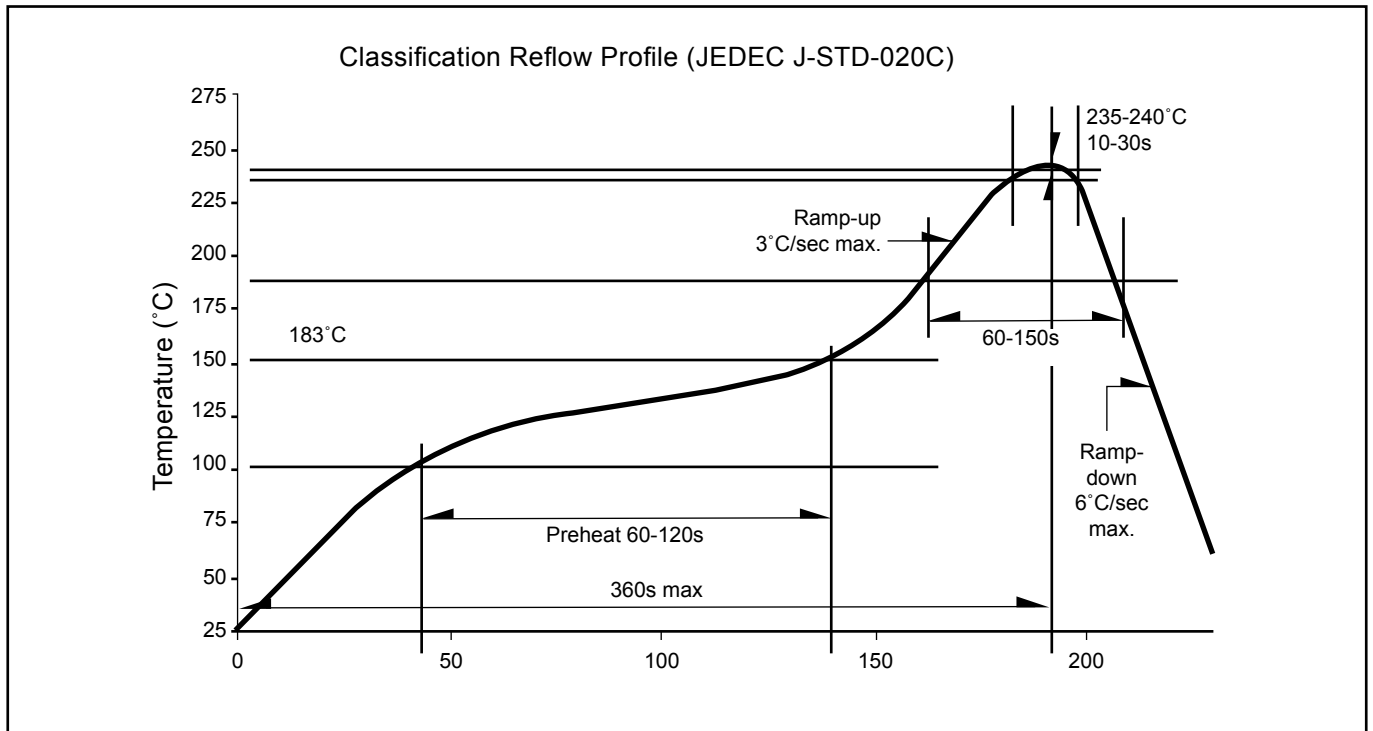

**Recommended Pb-free Soldering Profile**

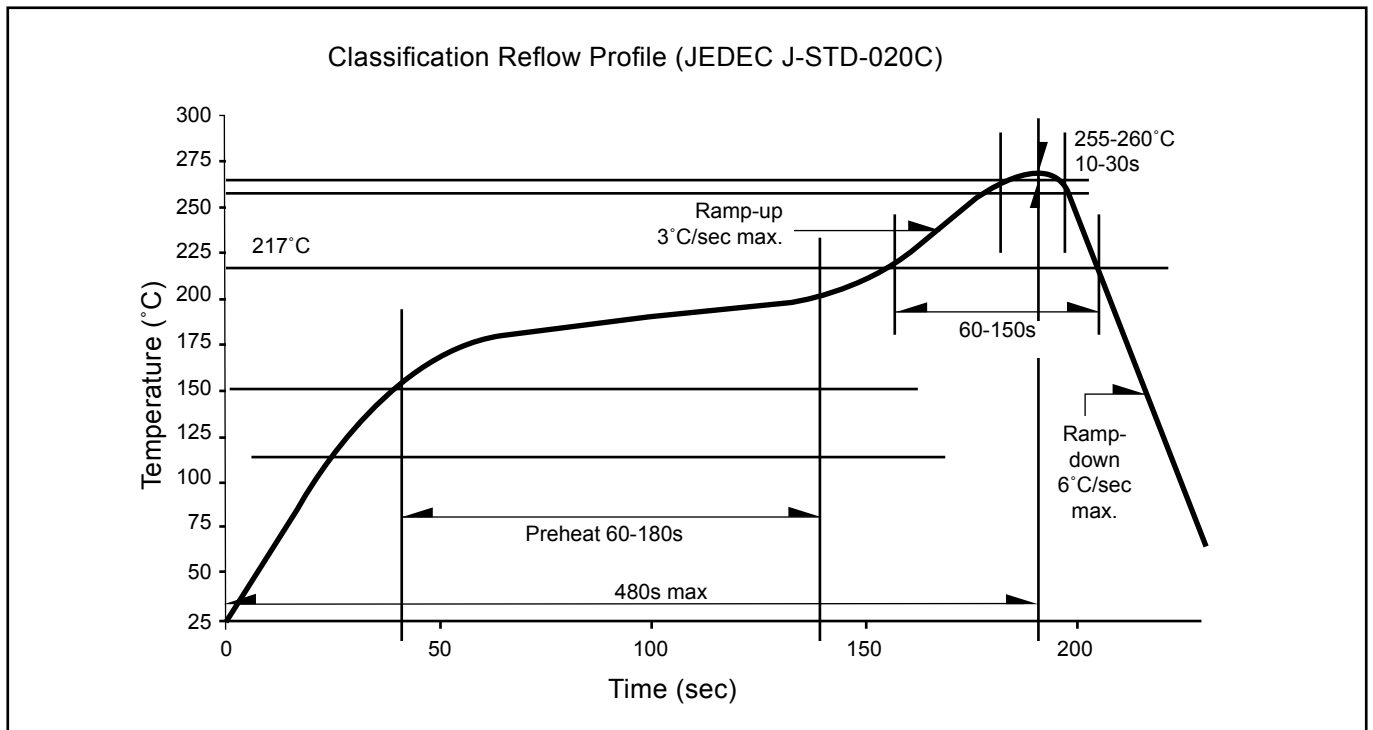



## About Us

DOMINANT Semiconductors is a dynamic Malaysian Corporation that is among the world's leading SMT LED Manufacturers. An excellence – driven organization, it offers a comprehensive product range for diverse industries and applications. Featuring an internationally certified quality assurance acclaim, DOMINANT's extra bright LEDs are perfectly suited for various lighting applications in the automotive, consumer and communications as well as industrial sectors. With extensive industry experience and relentless pursuit of innovation, DOMINANT's state-of-art manufacturing, research and testing capabilities have become a trusted and reliable brand across the globe. More information about DOMINANT Semiconductors can be found on the Internet at <http://www.dominant-semi.com>.

### **Please contact us for more information:**

#### Head Quarter

DOMINANT Semiconductors Sdn. Bhd.  
Lot 6, Batu Berendam, FTZ Phase III, 75350 Melaka, Malaysia  
Tel: (606) 283 3566 Fax: (606) 283 0566  
E-mail: [sales@dominant-semi.com](mailto:sales@dominant-semi.com)

#### DOMINANT China Sales Office

DOMINANT Semiconductors (Shenzhen) Co. Ltd.  
24BC Newbaohui Building, No. 1007 West Nanhai Blvd., Nanshan, Shenzhen, China P.C. 518054  
Tel: +86 (755) 86031785 / +86 (755) 86031786 Fax: +86 (755) 86031789  
E-mail: [sales\\_china@dominant-semi.com](mailto:sales_china@dominant-semi.com)

#### DOMINANT Korea Sales Office

DOMINANT Semiconductors Korea Inc.  
902 Sunil Technopia, 440 Sangdaewon-dong, Jungwon-gu, Sunghnam-si, Kyunggi-do, Korea 462726  
Tel: 82-31-777-3978 Fax: 82-31-777-3976  
E-mail: [sales\\_korea@dominant-semi.com](mailto:sales_korea@dominant-semi.com)

