

### SpiceLED<sup>™</sup>

Like spice, its diminutive size is a stark contrast to its standout performance in terms of brightness, durability and reliability. Despite being the smallest in size yet the SpiceLED<sup>™</sup> packs a powerful performance and is a highly reliable design device. Its versatility enables its application in automotive appliances, key-pad illumination, hand-held devices such as PDAs, notebooks, compact back-lighting applications, consumer appliances, office equipment, audio and video equipment.



### Features:

- > High brightness surface mount LED.
- > Super wide viewing angle of 160°.
- > Equivalent to 0603 package outline. Copper lead-frame construction.
- > Qualified according to JEDEC moisture sensitivity Level 2.
- > Compatible to IR reflow soldering.
- > Environmental friendly; RoHS compliance.



### Applications:

- > Automotive: Interior applications, eg: switches, telematics, climate control system, dashboard, etc
- > Signage: full colour display video notice board, signage, special effect lighting.



**Optical Characteristics at Tj=25°C**

Part Ordering Number	Color	Viewing Angle°	Luminous Intensity @ IF = 20mA IV (mcd)		
			Min.	Typ.	Max.
SSW-HLG-UV1-1	White	160	450.00	715.00	900.00
● SSW-HLG-T2U-1	White	160	355.00	500.00	715.00

● Not for new design

NOTE

1. All part number above comes in a quantity of 3000 units per reel.
2. Other luminous intensity groups are also available upon request
3. Luminous intensity is measured with an accuracy of ± 11%.
4. Wavelength binning is carried for all units as per the wavelength-binning table. Only one wavelength group is allowed for each reel.

Part Number	Vf @ If = 20mA			Vr @ Ir = 10uA
	Min. (V)	Typ. (V)	Max. (V)	Min. (V)
SSW-HLG	2.9	3.2	3.6	5

Forward voltage, Vf is measured with an accuracy of ± 0.1 V.

**Absolute Maximum Ratings**

	Maximum Value	Unit
DC forward current	30	mA
Peak pulse current; (tp ≤ 10µs, Duty cycle = 0.1)	100	mA
Reverse voltage; Ir <sub>max</sub> = 10µA	5	V
ESD threshold (HBM)	2000	V
LED junction temperature	110	°C
Operating temperature	-40 ... +100	°C
Storage temperature	-40 ... +100	°C
Power dissipation (at room temperature)	80	mW
Thermal resistance		
- Junction / ambient, R <sub>th JA</sub>	215	K/W
- Junction / solder point, R <sub>th JS</sub>	125	K/W
(Mounted on FR4 PCB; pad size ≥16mm <sup>2</sup> per pad)		

**Characteristics**

	Symbol	Part Number	Value	Unit
Temperature coefficient of $V_F$ (typ) $I_F = 20\text{mA}; 0\text{ }^\circ\text{C} \leq T \leq 100\text{ }^\circ\text{C}$	$TC_V$	SSW-HLG	-3.10	mV / K
Temperature coefficient of $I_V$ (typ) $I_F = 20\text{mA}; 0\text{ }^\circ\text{C} \leq T \leq 100\text{ }^\circ\text{C}$	$TC_{I_V}$	SSW-HLG	-0.18	% / K
Temperature coefficient of $C_x$ (typ) $I_F = 20\text{mA}; 0\text{ }^\circ\text{C} \leq T \leq 100\text{ }^\circ\text{C}$	$TC_{C_x}$	SSW-HLG	-0.00025	
Temperature coefficient of $C_y$ (typ) $I_F = 20\text{mA}; 0\text{ }^\circ\text{C} \leq T \leq 100\text{ }^\circ\text{C}$	$TC_{C_y}$	SSW-HLG	-0.00023	

**Wavelength Grouping**

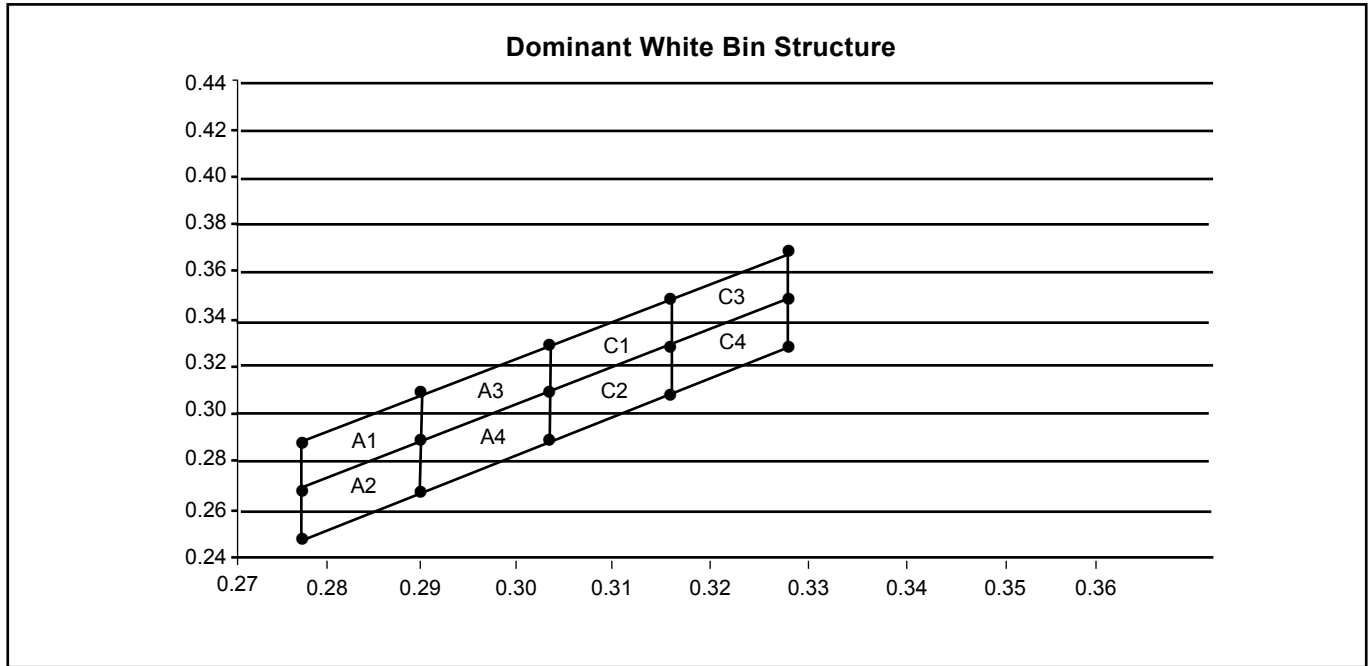

Chromaticity coordinate groups are measured with an accuracy of  $\pm 0.01$ .

Bin					
A1	Cx	0.2775	0.2900	0.2900	0.2775
	Cy	0.2732	0.2939	0.3114	0.2907
A2	Cx	0.2775	0.2900	0.2900	0.2775
	Cy	0.2557	0.2764	0.2939	0.2732
A3	Cx	0.2900	0.3025	0.3025	0.2900
	Cy	0.2939	0.3146	0.3321	0.3114
A4	Cx	0.2900	0.3025	0.3025	0.2900
	Cy	0.2764	0.2971	0.3146	0.2939
C1	Cx	0.3025	0.3150	0.3150	0.3025
	Cy	0.3146	0.3354	0.3529	0.3321
C2	Cx	0.3025	0.3150	0.3150	0.3025
	Cy	0.2971	0.3179	0.3354	0.3146
C3	Cx	0.3150	0.3275	0.3275	0.3150
	Cy	0.3354	0.3561	0.3736	0.3529
C4	Cx	0.3150	0.3275	0.3275	0.3150
	Cy	0.3179	0.3386	0.3561	0.3354

Dominant color coordinate is measured with an accuracy of  $\pm 0.01$ .

**Wavelength Grouping**

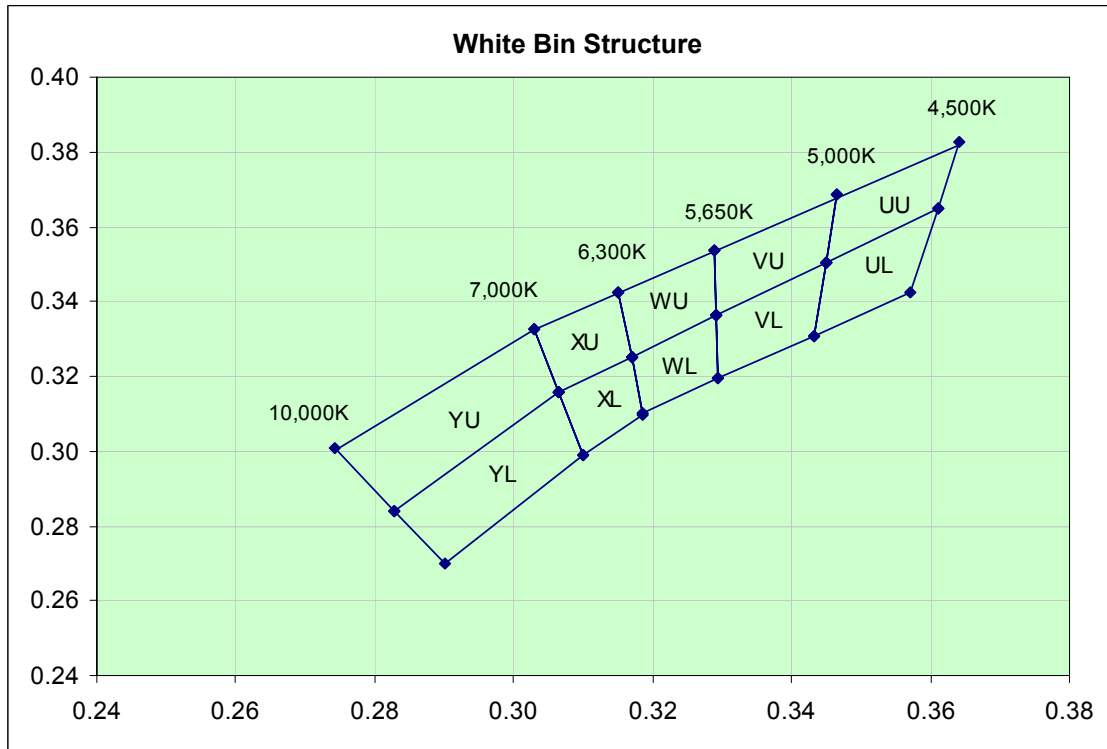

Chromaticity coordinate groups are measured with an accuracy of  $\pm 0.01$ .

Bin		1	2	3	4
YU	Cx	0.274	0.283	0.307	0.303
	Cy	0.301	0.284	0.316	0.333
YL	Cx	0.283	0.290	0.310	0.307
	Cy	0.284	0.270	0.299	0.316
XU	Cx	0.303	0.307	0.317	0.315
	Cy	0.333	0.316	0.325	0.343
XL	Cx	0.307	0.310	0.319	0.317
	Cy	0.316	0.299	0.310	0.325
WU	Cx	0.315	0.317	0.329	0.329
	Cy	0.343	0.325	0.336	0.354
WL	Cx	0.317	0.319	0.329	0.329
	Cy	0.325	0.310	0.319	0.336
VU	Cx	0.329	0.329	0.345	0.347
	Cy	0.354	0.336	0.350	0.368
VL	Cx	0.329	0.329	0.343	0.345
	Cy	0.336	0.319	0.331	0.350
UU	Cx	0.347	0.345	0.361	0.364
	Cy	0.368	0.350	0.365	0.383
UL	Cx	0.345	0.343	0.357	0.361
	Cy	0.350	0.331	0.343	0.365

Dominant color coordinate is measured with an accuracy of  $\pm 0.01$ .

**Luminous Intensity Group at Tj=25°C**

Brightness Group	Luminous Intensity @ IV (mcd)
T2	355.0...450.0
U1	450.0...560.0
U2	560.0...715.0
V1	715.0...900.0

Luminous intensity is measured with an accuracy of ± 11%.

**Vf Binning (Optional)**

Vf Bin @ 20mA	Forward Voltage (V)
01	2.90 ... 3.00
02	3.00 ... 3.10
03	3.10 ... 3.20
04	3.20 ... 3.30
05	3.30 ... 3.40
06	3.40 ... 3.50
07	3.50 ... 3.60

Forward voltage, Vf is measured with an accuracy of ± 0.1 V.

Please consult sales and marketing for special part number to incorporate Vf binning.

**Relative Luminous Intensity Vs Forward Current**

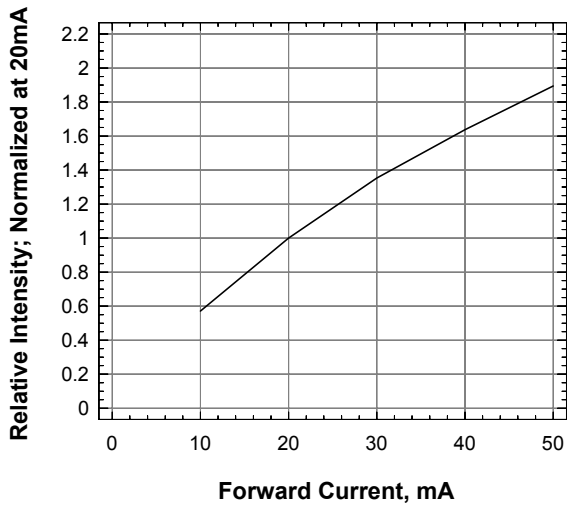

**Forward Current Vs Forward Voltage**

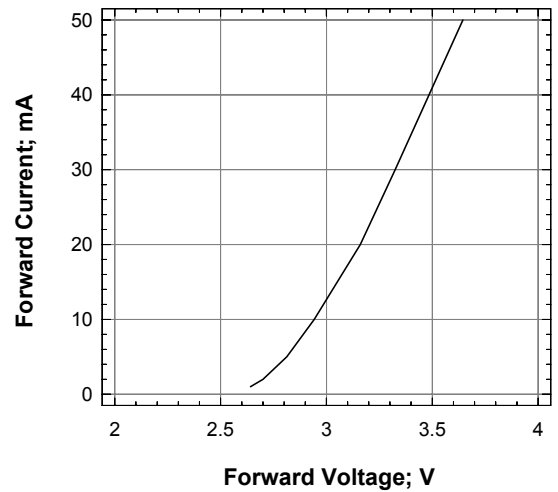

**Forward Current Vs Ambient Temperature**

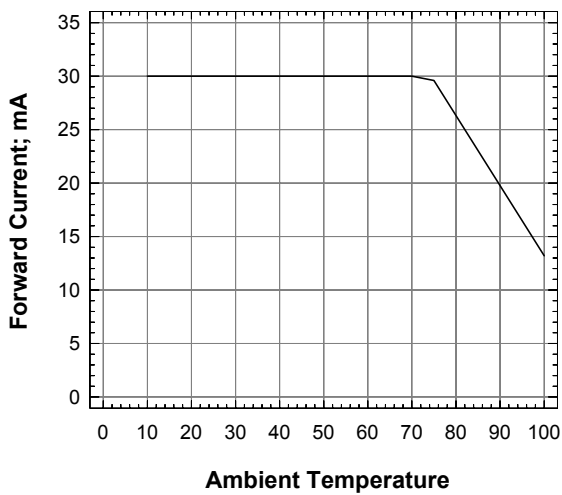

**Relative Intensity Vs Wavelength**

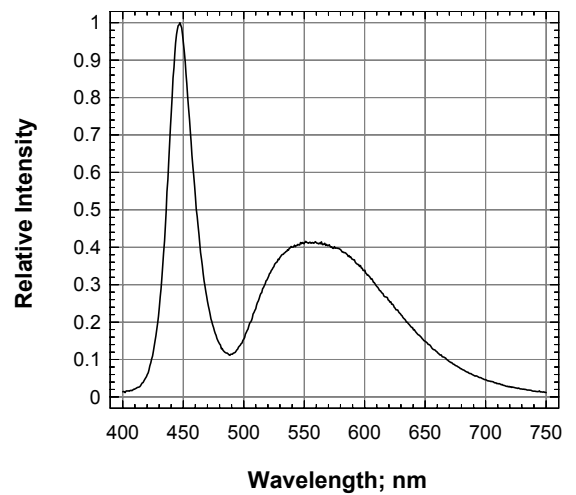

**Radiation Pattern**

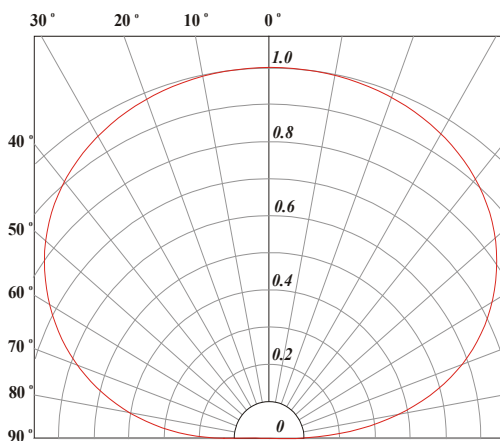

**SpiceLED™ • InGaN White S-Spice : SSW-HLG Package Outlines**

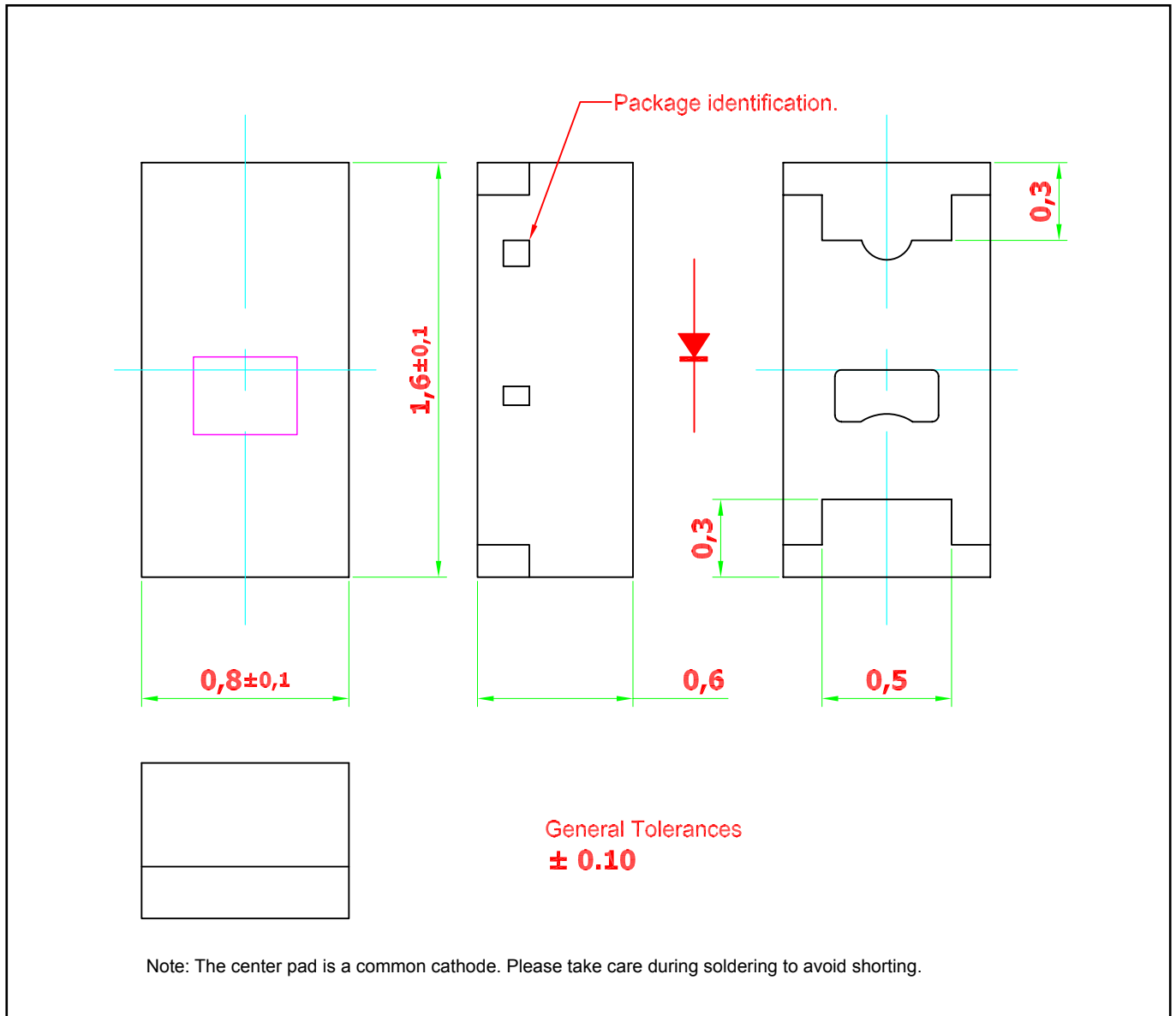

**Material**

Material	
Lead-frame	Cu Alloy With NiPdAu Plating
Package	High Temperature Resistant Epoxy Resin

Note: product is Pb free



**Recommended Solder Pad**

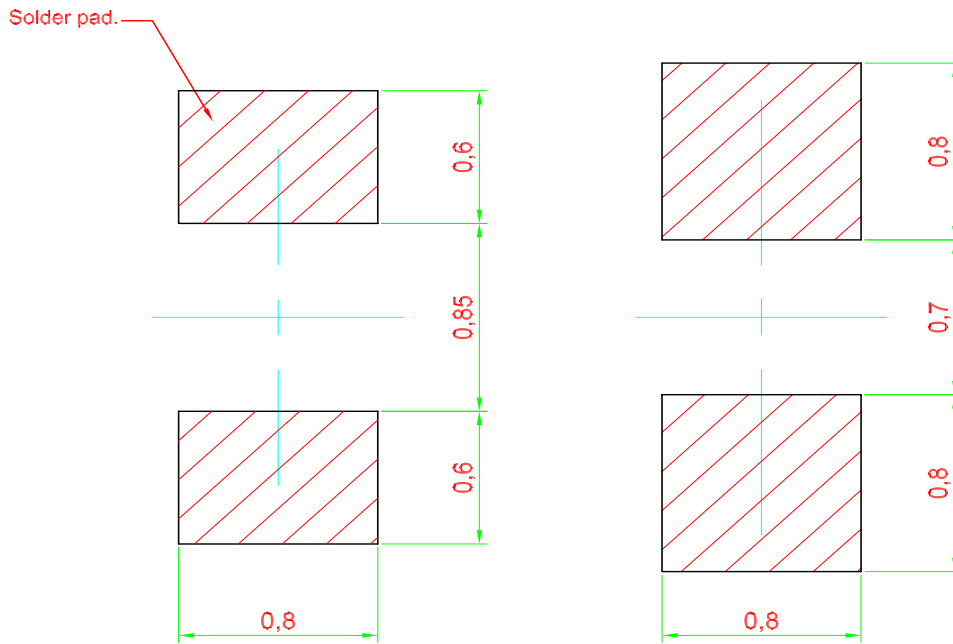

Recommended Solder-pad

Alternative Solder-pad  
 Compatible to ChipLED 0603

Note: Component is based on a new package platform, which features "Bottom Only Terminations". Solder joints are only formed at the bottom of the component and solder fillet will not be observable as the sides of the component.

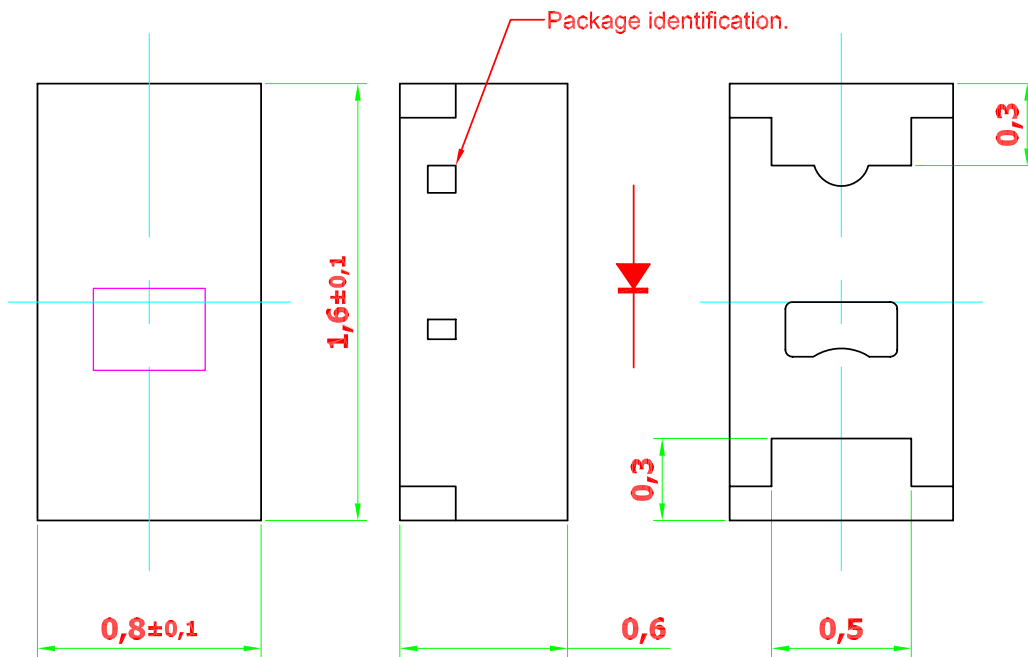

Surface are not intended for soldering

General Tolerances  
**± 0.10**

### Taping and orientation

- Reels come in quantity of 3000 units.
- Reel diameter is 180 mm.

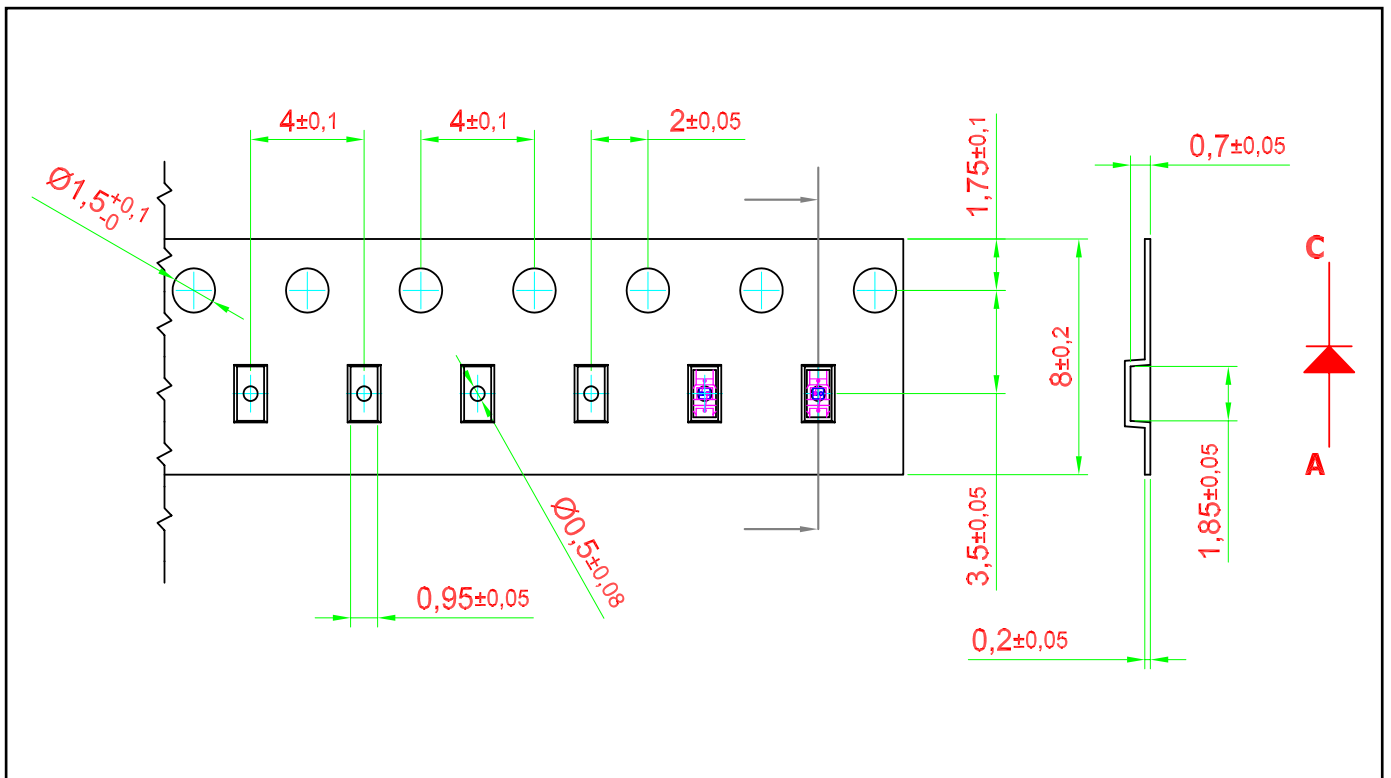

**Packaging Specification**

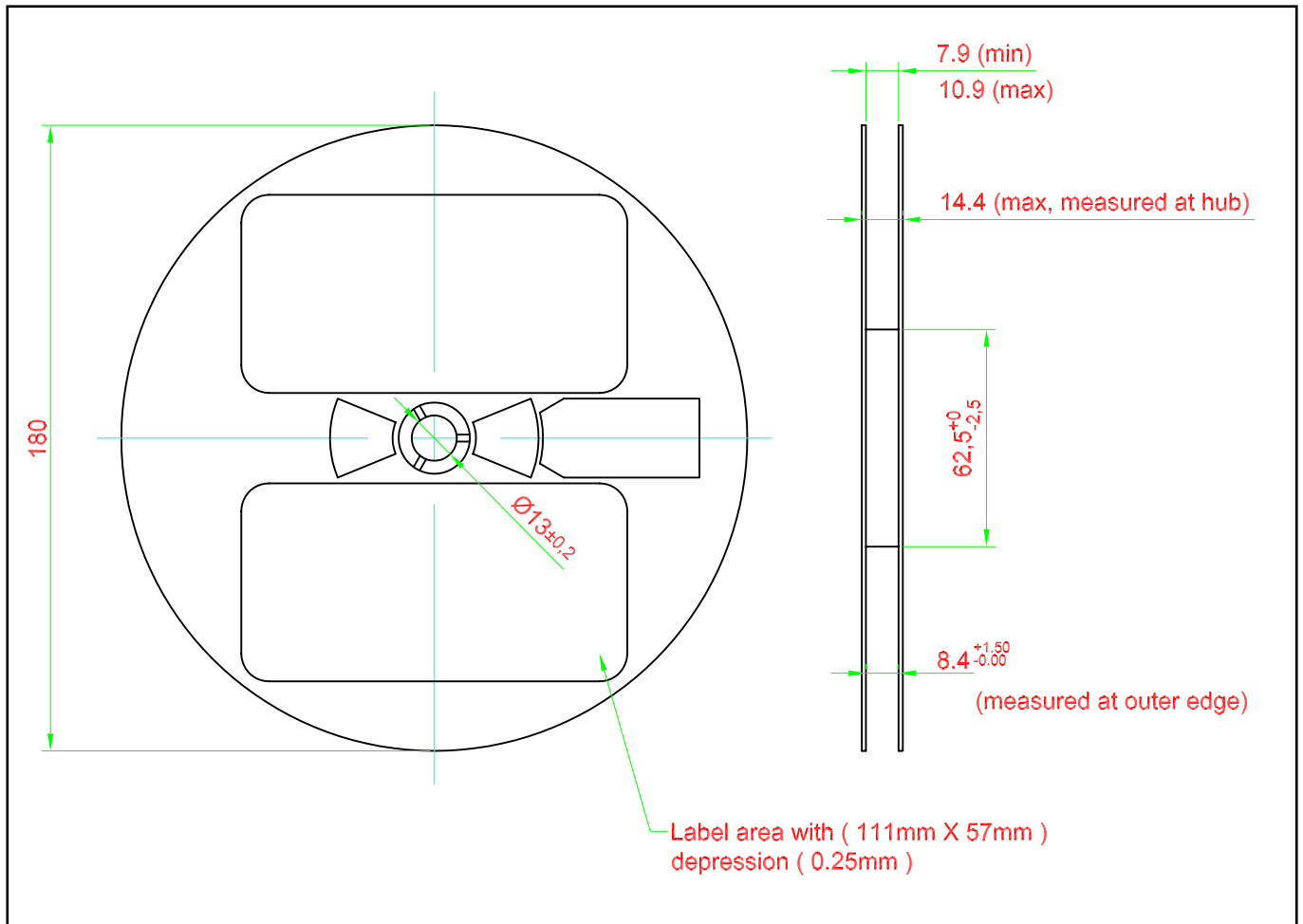

**Packaging Specification**

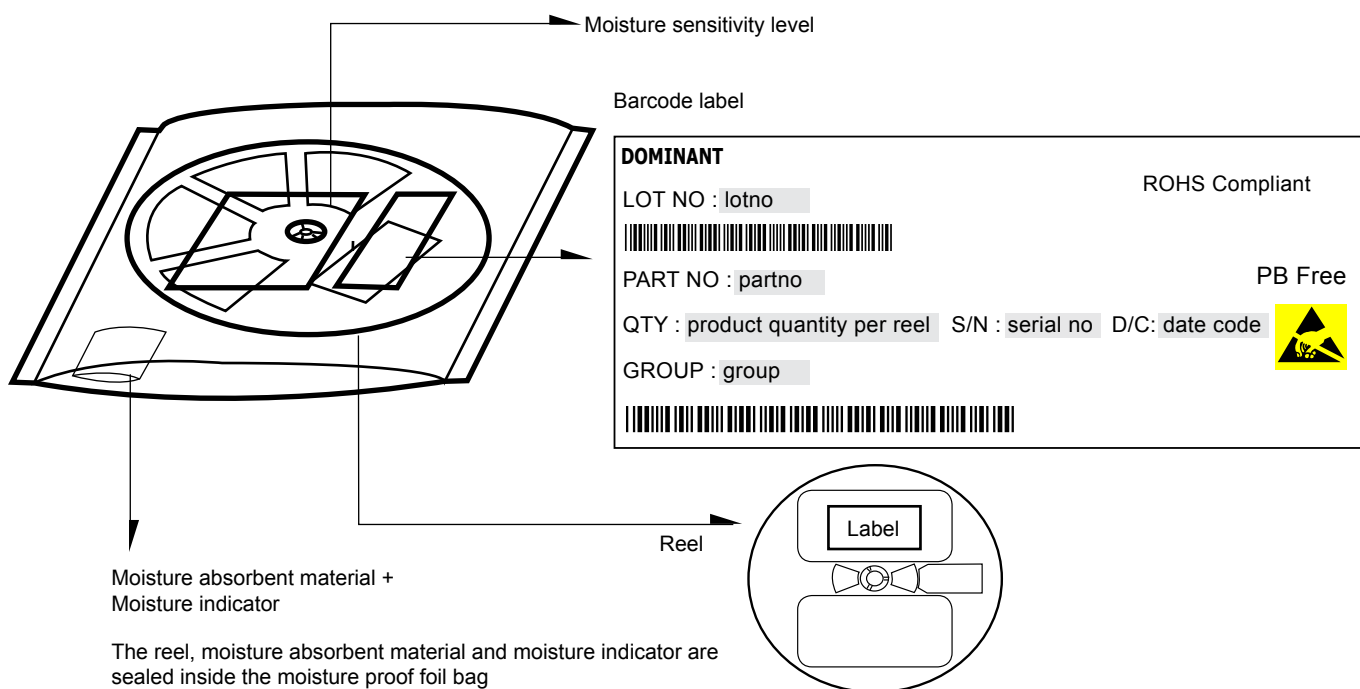

	Average 1pc SpiceLED	1 completed bag (3000pcs)
Weight (gram)	0.001	140 ± 10

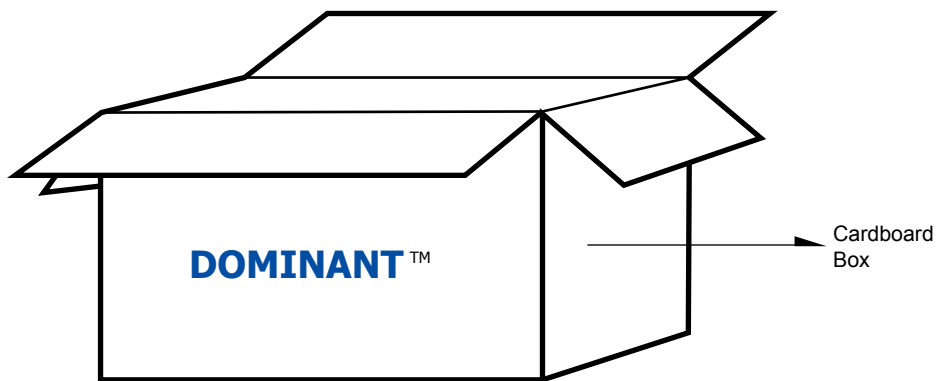

**For SpiceLED™**

Cardboard Box Size	Dimensions (mm)	Empty Box Weight (kg)	Reel / Box	Quantity / Box (pcs)
Small	300 x 250 x 250	0.58	15 reels MAX	45,000 MAX
Large	416 x 516 x 476	1.74	96 reels MAX	192,000 MAX

**Recommended Sn-Pb IR-Reflow Soldering Profile**

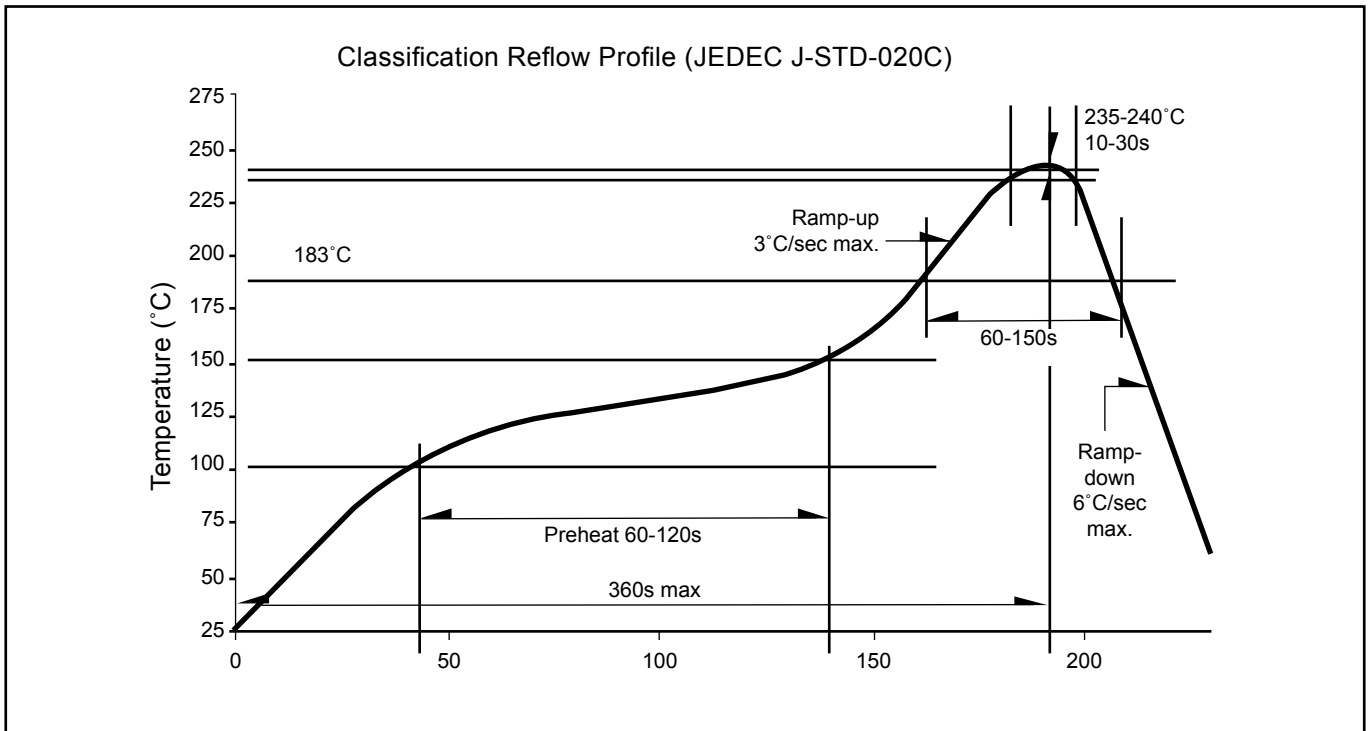

**Recommended Pb-free Soldering Profile**

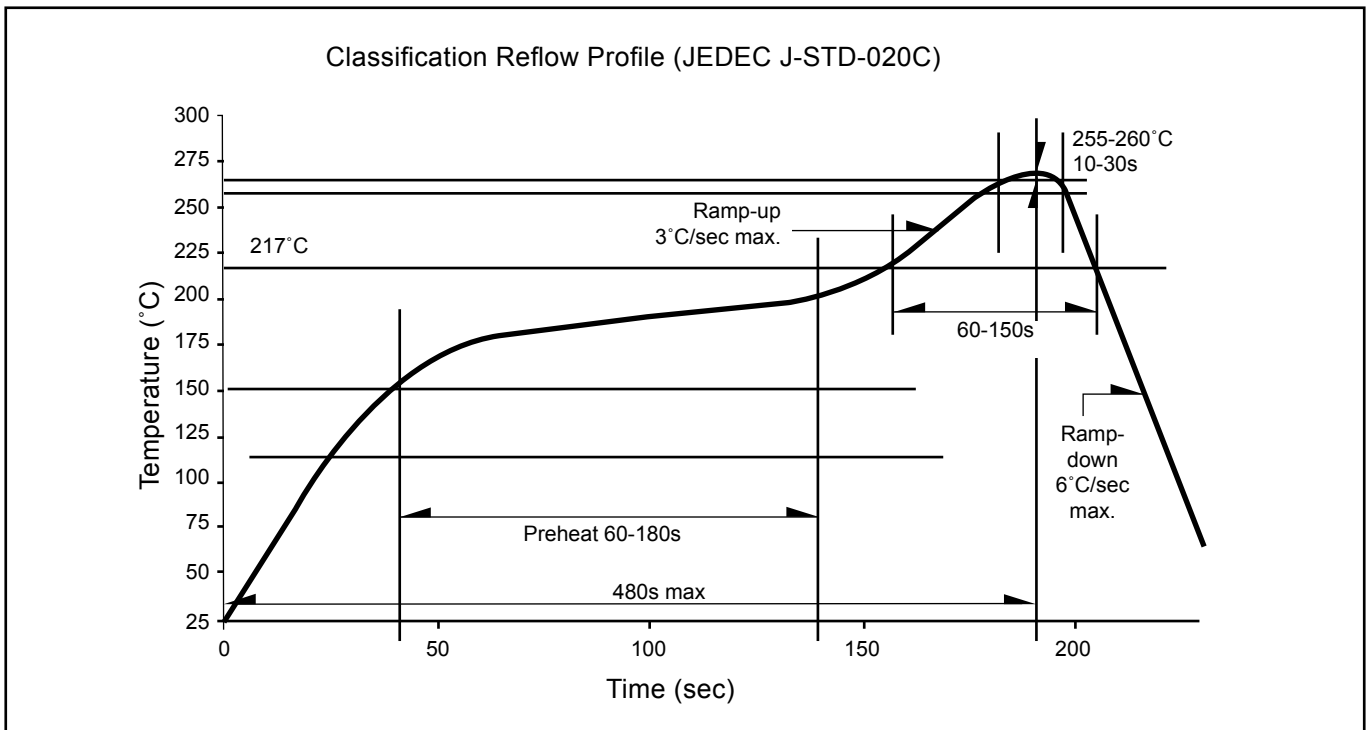

**Revision History**

Page	Subjects	Date of Modification
-	Initial release	04 Mar 2010
2	Add new partno:SSW-HLG-UV1-1 Not for new design: SSW-HLG-T2U-1	26 Mar 2010
5	Add Vf Binning	26 Oct 2010
3	Add Characteristics Add Thermal Resistance	08 Nov 2010

**NOTE**

All the information contained in this document is considered to be reliable at the time of publishing. However, DOMINANT Opto Technologies does not assume any liability arising out of the application or use of any product described herein.

DOMINANT Opto Technologies reserves the right to make changes at any time without prior notice to any products in order to improve reliability, function or design.

DOMINANT Opto Technologies products are not authorized for use as critical components in life support devices or systems without the express written approval from the Managing Director of DOMINANT Opto Technologies.

## About Us

DOMINANT Opto Technologies is a dynamic Malaysian Corporation that is among the world's leading SMT LED Manufacturers. An excellence – driven organization, it offers a comprehensive product range for diverse industries and applications. Featuring an internationally certified quality assurance acclaim, DOMINANT's extra bright LEDs are perfectly suited for various lighting applications in the automotive, consumer and communications as well as industrial sectors. With extensive industry experience and relentless pursuit of innovation, DOMINANT's state-of-art manufacturing, research and testing capabilities have become a trusted and reliable brand across the globe. More information about DOMINANT Opto Technologies can be found on the Internet at <http://www.dominant-semi.com>.

### **Please contact us for more information:**

#### Head Quarter

DOMINANT Opto technologies Sdn. Bhd.  
Lot 6, Batu Berendam, FTZ Phase III, 75350 Melaka, Malaysia  
Tel: (606) 283 3566 Fax: (606) 283 0566  
E-mail: [sales@dominant-semi.com](mailto:sales@dominant-semi.com)

#### DOMINANT Semiconductors Malaysia Sdn. Bhd. Shanghai Representative Office

DOMINANT Semiconductors (Shenzhen) Co. Ltd.  
Rm 1007, DaZhong Building, No. 1515 Zhong Shan (W) Rd, Shanghai, China 200235  
Tel: +86 21 6428 6428 Fax: +86 21 6428 6880  
E-mail: [sales\\_china@dominant-semi.com](mailto:sales_china@dominant-semi.com)

#### DOMINANT Korea Sales Office

DOMINANT Semiconductors Korea Inc.  
#709, Yatap Leaders Bldg., 342-1 Yatap-dong, Bundang-gu, Seongnam-si, Gyeonggi-do, 463-828 Korea.  
Tel: +82-31-701-5203 Fax: +82-31-701-5204  
E-mail: [sales\\_korea@dominant-semi.com](mailto:sales_korea@dominant-semi.com)

#### DOMINANT U.S.A Sales Office

25 Rockaway Road, 08833 Lebanon, New Jersey, USA  
Tel: (908) 439-9930 Cell: (908) 343-5810 Fax: (908) 439-9929  
E-mail: [don.wendel@dominant-semi.com](mailto:don.wendel@dominant-semi.com)

#### DOMINANT Europe Sales Office

DOMINANT Semiconductors Europe GmbH  
Raiffeisenstr. 38, 74906 Bad Rappenau Germany  
Tel: +49 (0) 7264-89010-10 / +49 (0) 7264-89010-11 Cell: +49 173-6907370 / +49 173-6907751  
Fax: +49 (0) 7264-89010-29  
E-mail: [gerd.wachno@dominant-semi.eu](mailto:gerd.wachno@dominant-semi.eu); [hartmut.wettengl@dominant-semi.eu](mailto:hartmut.wettengl@dominant-semi.eu)

#### DOMINANT India Sales Office

C-11, Vasanth Business Centre #86, TTK Road, Alwarpet Chennai - 600 018, INDIA  
Tel: 91-44-42030616 / 516 Cell: 91-9444920537 Fax: 91-9444920616  
E-mail: [pravat.behera@dominant-semi.com](mailto:pravat.behera@dominant-semi.com)

